

1

2

3

4

5

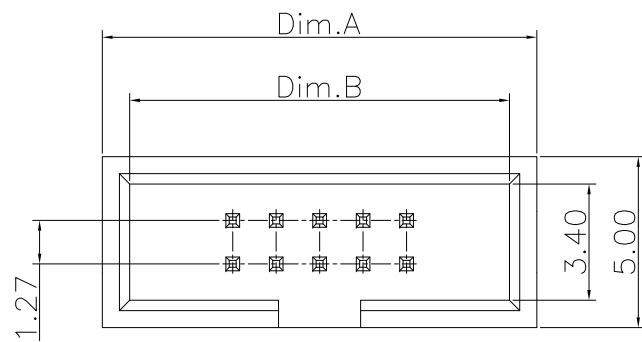

Pos	A	B	C	Pos	A	B	C
2*03P	10.16	8.56	2.54	2*15P	25.40	23.82	17.78
2*04P	11.43	9.83	3.81	2*17P	27.94	26.34	20.32
2*05P	12.70	11.10	5.08	2*20P	31.75	30.15	24.13
2*06P	13.97	12.37	6.35	2*22P	34.29	32.69	26.67
2*07P	15.24	13.64	7.62	2*25P	38.10	36.50	30.48
2*08P	16.51	14.91	8.89	2*30P	44.45	42.85	36.83
2*10P	19.05	17.45	11.43	2*32P	46.99	45.39	39.37
2*12P	21.59	19.99	13.97	2*34P	49.53	47.93	41.91
2*13P	22.86	21.26	15.24	2*40P	57.15	55.55	49.53
2*14P	24.13	22.53	16.51	2*50P	69.85	68.25	62.23

Specifications:

Current Rating:1.0A AC/DC

Voltage Rating:50V AC/DC

Contact Resistance:20m ohm .Max

Insulation Resistance:1,000M ohm. min.

Withstanding Voltage:500V AC

Operating Temperature Range:-40°C ~ +105°C

Material and Finish

Insulator: Ny 9T (UL94V-0)

Insulator Color:Black

Terminal:Brass

Plating:Gold Plated Over Nickel.

How To Order

2195S-XXX-TYJ

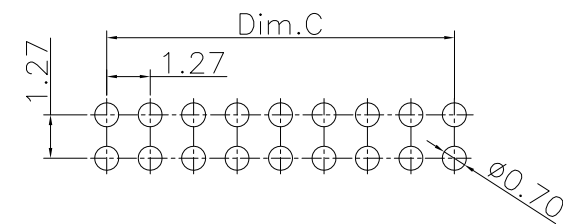
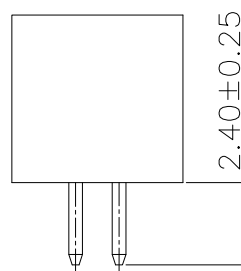
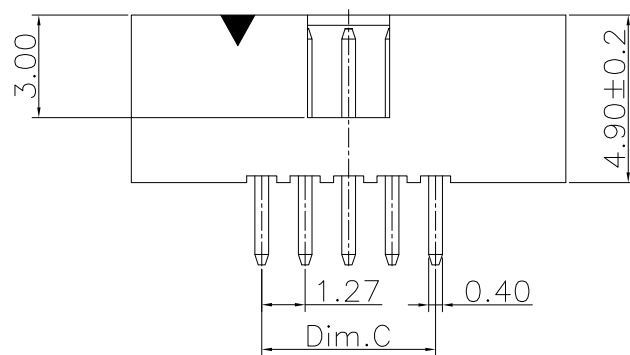
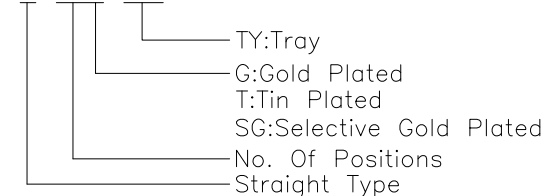

PCB Layout

RoHS Compliant

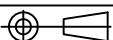
F				DRAWN: Lisy Liu	GENERAL TOLERANCE: .X=±0.20 .XX=±0.15	 Neltron Industrial Co., Ltd.	DESCRIPTION: 1.27 Pitch Box Header Straight Type	SIZE
E								
D				CHECKED: Jerry Chen	UNIT: MM	PART NO:	2195S-XXX-TYJ	A4
C					SCALE:			
B				APPROVAL: Rory Chen	SHEET: 1/2			
A	13-MAY-2020	(P0001)(PC0621)(J0066)	Lisy		PROJECTION: 			
REV	DATE	FILE	BY					